

Machine Vision Camera
GP-MF622

Operating Instructions



Panasonic

Before attempting to connect or operate this product,
please read these instructions completely.

**CAUTION**

RISK OF ELECTRIC SHOCK
DO NOT OPEN

**CAUTION:**

TO REDUCE THE RISK OF ELECTRIC SHOCK,
DO NOT REMOVE COVER (OR BACK). NO
USER-SERVICEABLE PARTS INSIDE.
REFER SERVICING TO QUALIFIED SERVICE
PERSONNEL.

**SA 1966**

The exclamation point within an equilateral triangle is intended to alert the user to the presence of important operating and maintenance (servicing) instructions in the literature accompanying the appliance.

Warning:

This equipment generates and uses radio frequency energy and if not installed and used properly, i.e., in strict accordance with the instruction manual, may cause harmful interference to radio communications. It has been tested and found to comply with the limits for a Class A computing device pursuant to Subpart J of Part 15 of FCC Rules, which are designed to provide reasonable protection against such interference when operated in a commercial environment.

**SA 1965**

The lightning flash with arrow-head symbol, within an equilateral triangle, is intended to alert the user to the presence of uninsulated "dangerous voltage" within the product's enclosure that may be of sufficient magnitude to constitute a risk of electric shock to persons.

WARNING: TO PREVENT FIRE OR ELECTRIC SHOCK HAZARD, DO NOT EXPOSE THIS APPLIANCE TO RAIN OR MOISTURE.

CONTENTS

PREFACE	2
FEATURES	2
PRECAUTIONS	3
MAJOR OPERATING CONTROLS AND THEIR FUNCTIONS	5
PREPARATIONS	9
SYSTEM CONNECTIONS	10
EXTERNAL SYNCHRONIZATION	11
PREVENTION OF BLOOMING AND SMEAR ..	11
SPECIFICATIONS	12
OPTIONAL ACCESSORIES	13

Remove dust on the faceplate of filter glass before mounting the lens on the camera.

The serial number of this product may be found on the top of the unit.

You should note the serial number of this unit in the space provided and retain this book as a permanent record of your purchase to aid identification in the event of theft.

Model No. _____

Serial No. _____

PREFACE

The Panasonic GP-MF622 Machine Vision Camera has a 1/2" Interline Transfer CCD image sensor which features 380 000 pixels, a horizontal resolution of 570 lines, and minimum smear.

FEATURES

1. Newly developed multi-function solid state image sensor 1/2" Inter Line Transfer type CCD image sensor with 768 (H) x 494 (V) pixels.
2. Selectable scanning system :
1-line interlace and 2-line interlace are available for the highest quality possible within video processing.
3. External synchronization :
External HD/VD input enables system setup with external video processors, etc.
4. Frame Reset :
External HD and VD reset signals reset the scanning line to the line number 1.
5. High speed shutters up to 1/96 000 second with trigger function enable to achieve strobe-less machine vision system.

PRECAUTIONS

- 1. Do not attempt to disassemble the camera.**
To prevent electric shock, do not remove screws or covers.
There are no serviceable parts inside. Ask a qualified service person for servicing.
- 2. Handle the camera with care.**
Do not abuse the camera. Avoid striking, shaking, etc. The camera could be damaged by improper handling or shortage.
- 3. Do not expose the camera to rain or moisture, or try to operate it in wet areas.**
This camera is designed for indoor use.
Turn the power off immediately and ask a qualified service person for servicing.
Moisture can damage the camera and also create the danger of electric shock.

- 4. Do not use the strong or abrasive detergents when cleaning the camera body.**
Use a dry cloth to clean the camera when dirty.
In case the dirt is hard to remove, use a mild detergent and wipe gently.
- 5. Clean the CCD faceplate with care.**
Do not clean the CCD with strong or abrasive detergents. Use lens tissue or a cotton tipped applicator and ethanol.
- 6. Never face the camera towards the sun.**
Do not aim the camera at bright objects. Whether the camera is in use or not, never aim at the sun or other extremely bright objects. Otherwise, blooming or smear may be caused.

7. Do not drop anything inside the camera.

Dropping metal for example inside the camera could permanently damage the unit. If anything is dropped inside the camera, turn the power off immediately and ask a qualified service person for servicing.

8. Do not operate the camera beyond the specified temperature, humidity or power source ratings.

Use the camera under conditions where temperature is between -10°C - $+50^{\circ}\text{C}$ (14°F - 122°F), and humidity is below 90 %. The input power source is DC 12 V, 170 mA.

MAJOR OPERATING CONTROLS AND THEIR FUNCTIONS

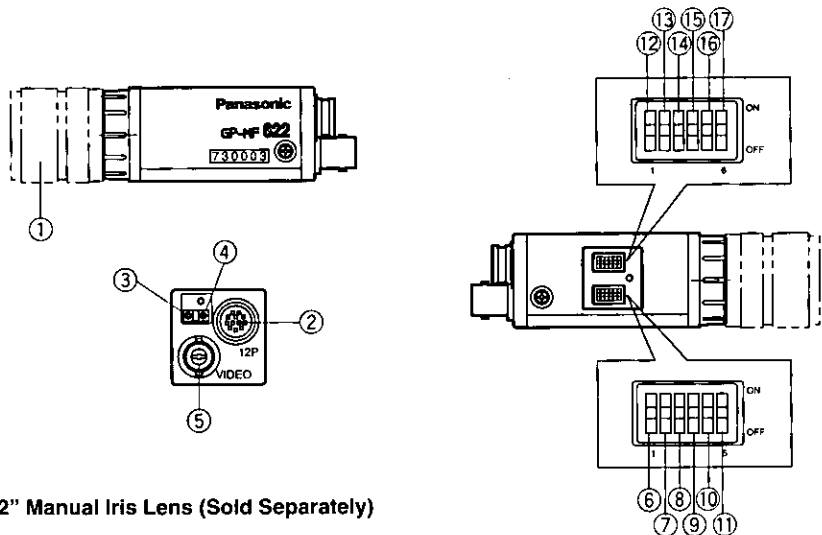

1. 1/2" Manual Iris Lens (Sold Separately)

2. Camera Connector (12-pin)

This is connected with the optional Camera Cable GP-CA34 , GP-CA33, GP-CA59 or GP-CA60.

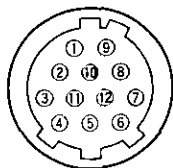

CAUTION: CONNECT THIS TO A DC 12V CLASS 2 POWER SUPPLY ONLY.

Pin No.	Description
1	Ground
2	+12V IN
3	Ground for Video Out
4	Video Out
5	Ground for HD
6	HD IN
7	VD/V reset/V cont IN
8	Ground
9	No connection
10	No connection
11	No connection
12	Ground for VD

3. Pedestal Control

This controls the pedestal level from 0 mV to 100 mV.

4. Manual Gain Control

This controls the gain level from 0 to 6 dB.

5. Video Output Connector

This connector is used to connect with the VIDEO IN connector of the monitor.

6. Switch 1 No.1 (1/ON) 1 ON

This switch selects the Field or Frame Accumulation.

ON : Field Accumulation

OFF: Frame Accumulation

7. Switch 1 No.2 (2/ON) 2 ON

8. Switch 1 No.3 (3/ON) 3 ON

9. Switch 1 No.4 (4/ON) 4 ON

10. Switch 1 No.5 (5/ON) 5 ON

These switches (Switch 1 No. 2, 3, 4, and 5) are used to set the shutter speed. The shutter speed changes according to the mode which is set by the switch. (See following pages to select mode by settings for Switch 2.)

The shutter speed can be set as below:

Switch 1				Mode		
No. 2	No. 3	No. 4	No. 5	A	B	C
OFF	OFF	OFF	OFF	Normal	1/2 000	1/2 000
ON	OFF	OFF	OFF	1/100	1/2 000	1/2 000
OFF	ON	OFF	OFF	1/500	1/2 000	1/2 000
ON	ON	OFF	OFF	1/1 000	1/2 000	1/2 000
OFF	OFF	ON	OFF	1/2 000	1/2 000	1/2 000
ON	OFF	ON	OFF	1/4 000	1/4 000	1/4 000
OFF	ON	ON	OFF	1/8 000	1/8 000	1/10 000
ON	ON	ON	OFF	1/16 000	1/16 000	1/30 000
OFF	OFF	OFF	ON	1/32 000	1/32 000	Not Specified
ON	OFF	OFF	ON	1/64 000	1/64 000	Not Specified
OFF	ON	OFF	ON	1/96 000	1/96 000	Not Specified
Other Combinations				Not Specified	Not Specified	Not Specified

11. Switch 1 No.6 (6/ON) 6 ON

This switch is not available for this model.

12. Switch 2 No.1 (1/ON) 1 ON

13. Switch 2 No.2 (2/ON) 2 ON

These switches (Switch 2 No.1 and 2) are used to set the mode. You can select the mode from A, B, and C mode.

The mode can be set as below:

Switch 2		Mode
No. 1	No. 2	
OFF	OFF	A mode : Internal, HD/VD
ON	OFF	B, C mode : V reset
OFF	ON	D mode : V cont
Other Combinations		Not Specified

14. Switch 2 No.3 (3/ON) 3 ON

When V reset is selected (Switch 2 No.1 is ON and No.2 is OFF), this switch selects B mode or C mode.

B mode: V reset Latch off

C mode: V reset Latch on

15. Switch 2 No.4 (4/ON) 4 ON

When V cont is selected (Switch 2 No.1 is OFF and No.2 is ON), set this switch to ON and Switch 2 No.6 to OFF.

16. Switch 2 No.5 (5/ON) 5 ON

This switch turns on or off the termination for HD signal with 75 Ω .

17. Switch 2 No.6 (6/ON) 6 ON

This switch turns on or off the termination for VD signal with 75 Ω .

When V cont is selected (Switch 2 No.1 is OFF and No.2 is ON), set this switch to OFF and Switch 2 No.4 to ON.

PREPARATIONS

1. Power Supply for Camera

Prepare a regulated DC power supply which can supply DC 12 V \pm 10 % DC 170 mA or more current and rated CLASS 2.

2. Lenses

Be sure to use the optional manual iris lens having the following items.

Focus : Adjustable

Lens Weight : Less than 300 g (0.66 lbs.)

Note: If the lens is heavier than 300 g (0.66 lbs.), both the lens and the camera should be secured by using the supporter.

Mount : C-mount

The protrusion at the rear of the lens should be as shown in the illustration.

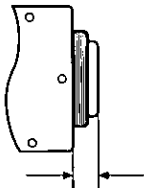

Less than 5/6" (Less than 8 mm)

3. Switch Covers Removal

Caution: The following preparation should be made by qualified service personnel or system installers.

For setting the Switch 1 No.1 to 6 and 2 No. 1 to 6, remove the switch cover fixing screw on the side panel as shown below.

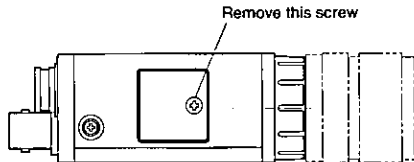

And to control the pedestal level or gain level, remove the cover fixing screw on the rear panel as shown below.

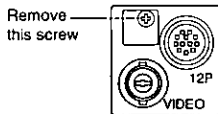

SYSTEM CONNECTIONS

Caution: Keep the power switches of all units to OFF before connections.

1. Connect the optional camera cable GP-CA34 between the connector of this camera and the 12V DC Class 2 power supply(not provided as an accessory).
2. Connect the video connector of the GP-CA34 to the Video Monitor.

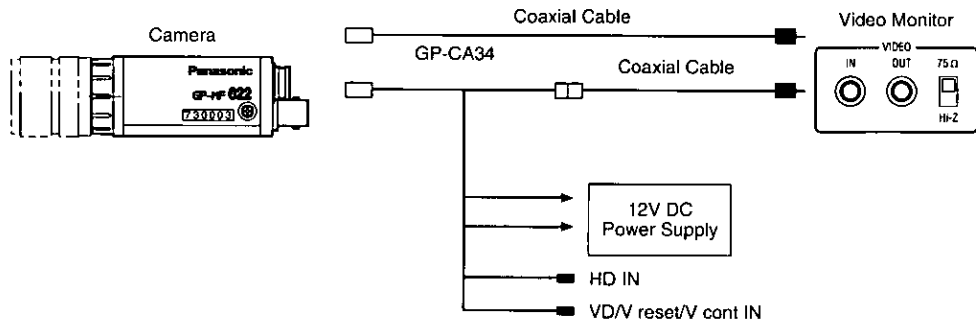

Caution: Use a 12V DC Class 2 Power Supply only

EXTERNAL SYNCHRONIZATION

2 : 1 Interlace

The GP-MF622 works in 2 : 1 interlace mode when external 2 : 1 interlaced HD/VD signal is supplied to pin-6 and pin-7 of the camera connector (12-pin).

Note: If the picture appears disturbed, be sure to match the phases of falling edges of the external HD/VD.

PREVENTION OF BLOOMING AND SMEAR

When the camera is aimed at a bright light, such as a spotlight, or a surface that reflects bright light, smear or blooming may appear. therefore, the camera should be operated carefully in the vicinity of extremely bright objects to avoid smear or blooming.

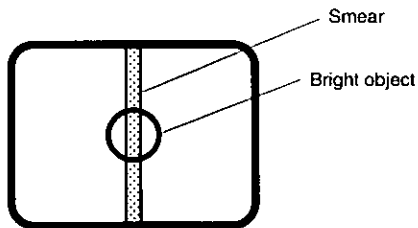

SPECIFICATIONS

Pick-up Device :	Inter Line Transfer type CCD with 768 (H) x 494 (V) pixels.
Image Size :	1/2" (7.95 (H) x 6.45 (V) mm) 2 : 1 interlace 1-line interlace (Frame accumulation) 2 : 1 interlace 2-line interlace (Field accumulation)
Synchronization :	Internal or External (Selectable Automatically) Internal : Built-in sync generator External : 4.0 V[p-p]/75 Ω Horizontal drive and Vertical drive pulses for 2 : 1 interlace
External Reset :	External signal (4.0 V[p-p]/75 Ω , negative) supplied to EXT VD IN connector can be used as reset signal
Horizontal Resolution :	570 lines at center
Minimum Illumination :	1.0 lx (0.1 foot-candles), (F1.4, Manual Gain Max (+6 dB), γ OFF, 2 : 1 interlace, without shutter)
Signal to Noise Ratio:	56 dB Typical (Fix Gain OFF (0 dB), γ OFF, 2:1 interlace without shutter)
Gamma :	1.0
Gain Selection :	0 - 6 dB (Adjustable by Manual Gain Control on rear panel)
Electronic Shutter :	10-step (1/100 s to 1/96 000 s) at normal 7-step (1/2 000 s to 1/96 000 s) at Shutter Trigger Mode B. 4-step (1/2 000 s to 1/30 000 s) at Shutter Trigger Mode C.
Lens Mount :	C-Mount

Vibration Resistance :	10 G (10 Hz - 150 Hz) (2 hours each for three axes)
Shock Resistance :	80 G (IEC 68) *IEC=International Electronical Technical Commission
Power Source :	DC + 12 V, 170 mA
Ambient Temperature :	-10°C - +50°C (14°F - 122°F)
Dimensions :	29(W) x 29(H) x 65(D) mm [1-1/8"(W) x 1-1/8"(H) x 2-13/16"(D)]
Weight :	86 g (0.19 lbs.) (Camera Only)

Dimensions and weight indicated are approximate values.
Specifications are subject to change without notice.

OPTIONAL ACCESSORIES

Camera Cable	GP-CA34
	GP-CA33
	GP-CA59
	GP-CA60

Panasonic

Medical & Industrial Video Company

**A Division of Panasonic Broadcast & Television Systems Company
A Unit of Matsushita Electric Corporation of America**

Executive Office: One Panasonic Way 4D-4, Secaucus, New Jersey 07094 (201)392-6674

PANASONIC CANADA INC.

5770 Ambler Drive, Mississauga, Ontario, L4W 2T3 Canada (905)624-5010

PANASONIC SALES COMPANY

DIVISION OF MATSUSHITA ELECTRIC OF PUERTO RICO, INC.

San Gabriel Industrial Park, 65th Infantry Ave. KM. 9.5 Carolina, P.R. 00630 (809)750-4300